

# Europa



**Tondo scorrevole a quattro ante,**  
due fisse laterali e due apribili frontali.

**Pari de douche 1/4 de rond à quatre panneaux,**  
ouverture centrale par deux panneaux coulissants sur deux panneaux fixes.

**Quadrant enclosure with four panels,**  
central opening with sliding doors (two lateral fixed and two frontal can be opened).

**Semicircular con cuatro paneles,**  
apertura central con dos hojas correderas y dos fijas.

**4-tlg. Runddusche mit zentraler Öffnung,**  
zwei festen und zwei Schiebetüren.

**Kwartronde met vier panelen,**  
centraal openschuivende kwartronde douchewand met twee vaste en twee openschuivende panelen.

**Круглая конструкция с раздвижной**  
**четырёхстворчатой дверью,** двумя стационарными боковыми и двумя открывающимися фронтальными створками.

5 anni di garanzia\_Garantie 5 an\_5 Years Warranty\_  
Garantia De 5 Años\_5 Jahre Garantie\_5 Jaar  
Garantie\_ЛЕТ ГАРАНТИЯ

5



H 200 cm. - V 6 mm.

## Finitura profili

Finitions des profilés\_Profiles finishing \_Acabado perfiles  
Profilfarbe\_Profil afwerkingen \_Отделка профилей

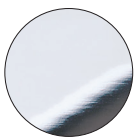

**ULU**  
**brillantato cromo**  
chromé brillant  
brilliant chrome  
aluminio cromo  
Chrom glänzend  
glanzend chrom  
светлый блестящий хром

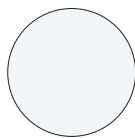

**L01**  
**bianco**  
blanc  
white  
blanco  
Weiß  
wit  
белый

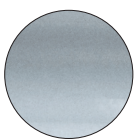

**SAR**  
 **satinato argento**  
satiné argent  
silver glazed satin  
satinado plata  
Satinierter silber  
satijn zilver  
сатинированное  
серебро

## Finitura pannelli

Finitions des panneaux\_Panels finishing \_Acabado perfiles  
Glasart\_Paneel afwerkingen \_Отделка панелей

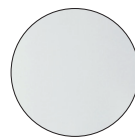

**TR**  
**trasparente**  
transparent  
transparent  
transparente  
Klarglas  
transparent  
прозрачное



**ST**  
**Stampato**  
granité  
frosté  
estampado  
Bedrucktes Glas  
gemarteld  
узорчатое

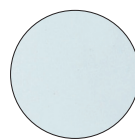

**AS**  
**Satinato Acqua**  
satiné Acqua  
satin Acqua  
satinado Acqua  
Satiniertes Glas Acqua  
satijn Acqua  
сатинированное Acqua

## Tondo scorrevole a quattro ante

1/4 de rond coulissant à quatre panneaux

Quadrant enclosure with four panels

Semicircular con quatro paneles

4-tlg. Runddusche mit Seitenöffnung

Kwartronde met vier panelen

Круглая конструкция с четырехстворчатыми раздвижными дверьми



Trattamento anticalcare di serie compreso nel prezzo

Traitement anti-calcaire inclus dans le prix

Anti-limescale treatment included in the price

Tratamiento antical incluido en el precio

Gegen Kalkablagerungen schützende Glasbehandlung im Preis begriffen

Anti-kalkafwerking inbegrepen in de prijs

Средство от известкового налета включено в цену

Z [cm]	Cod.	A [cm]	B [cm]	C [cm]	[dm <sup>3</sup> ]	[kg]	[n°]
76,5-79,5	B7853	22,5-25,5	41	39	249	50	2
86,5-89,5	B7852	32,5-35,5	41	47	287	56	2
96,5-99,5	B7854	42,5-45,5	41	47	346	62	2

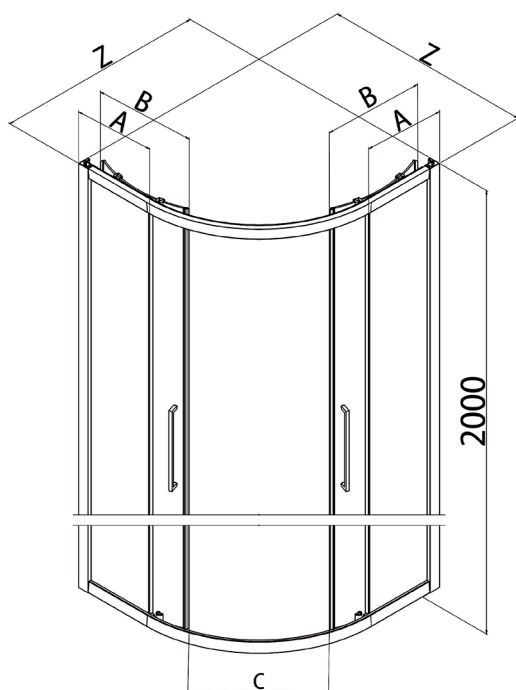

**320 mm**

Interasse maniglia

Empattement de la poignée

Handle wheelbase

Distancia entre ejes de la manija

Radstand handhaben

Handvat wielbasis

Колесная база ручки

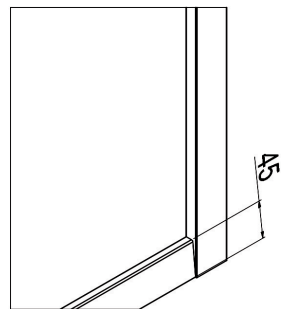
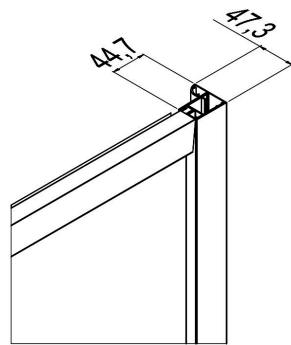
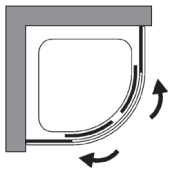
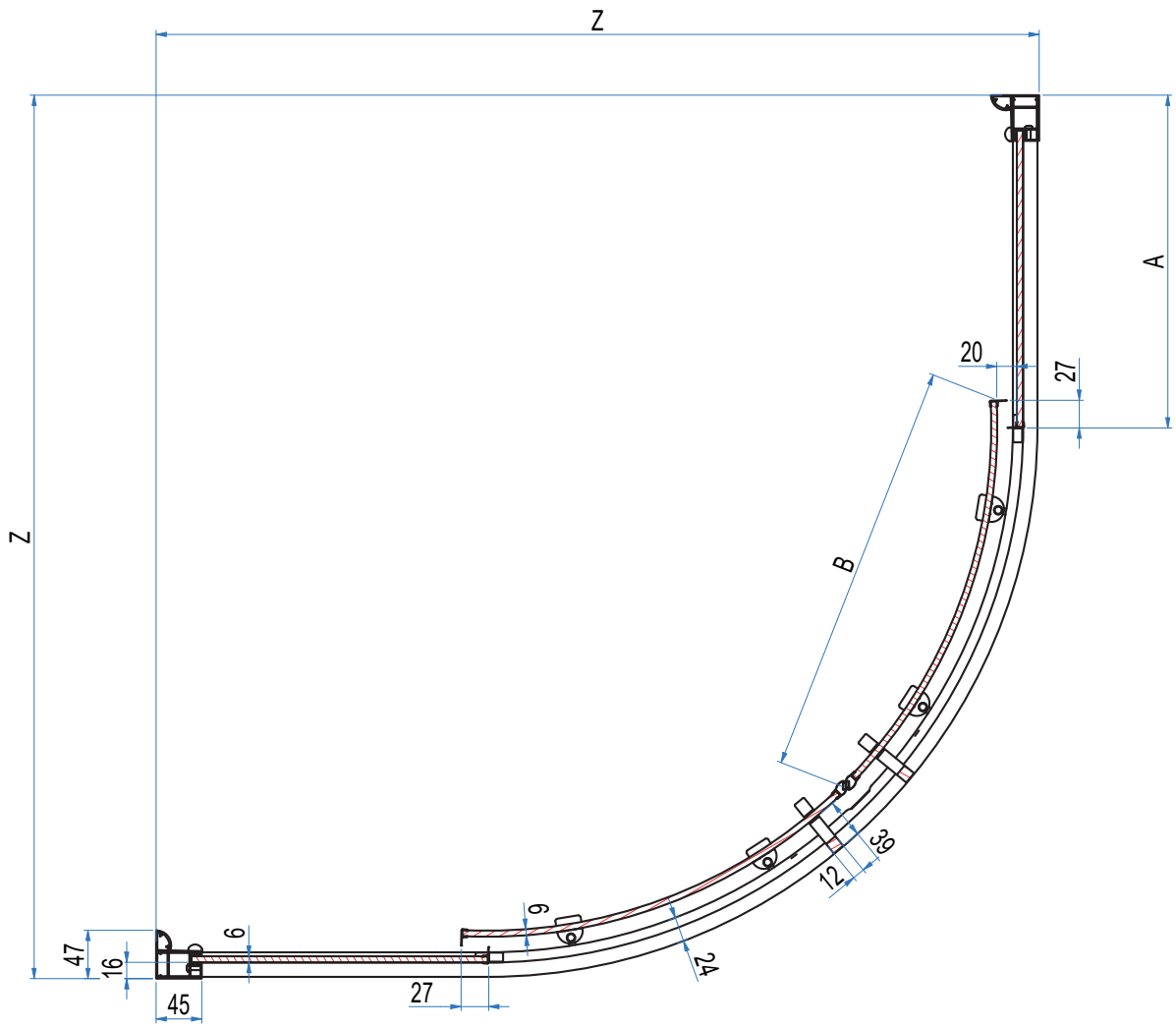



Prodotti Speciali - Produits Spéciaux - Special products - Productos Especiales - Sonderaufertigungen - Maatwerk - Специальные Иродукты

MISURE LIMITE	Altezza max 200 cm.	//	//	
MESURES LIMITES	Hauteur max 200 cm.	//	//	
LIMITS OF MEASUREMENTS	Height max 200 cm.	//	//	
MEDIDAS LIMITE	Altura max 200 cm.	//	//	
GRENZMAßE	Höhe max 200 cm.	//	//	
EXTREME MATEN	Hoogte max 200 cm.	//	//	
ПРЕДЕЛЬНЫЕ РАЗМЕРЫ:	Макс. высота 200 см	//	//	

	I								
	II								
	III								

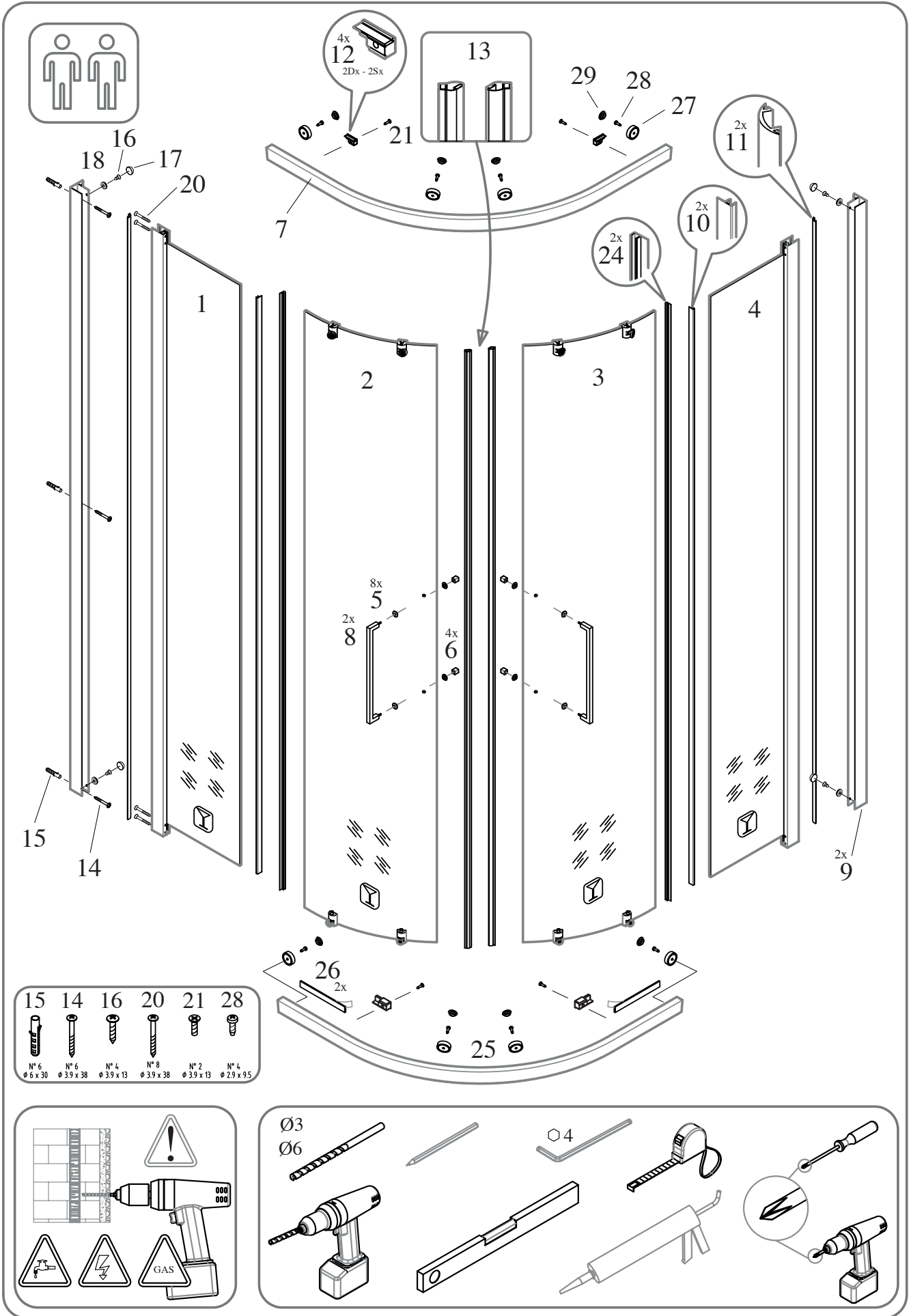

15	14	16	20	21	28
N° 6 Ø 6 x 30	N° 6 Ø 3,9 x 38	N° 4 Ø 3,9 x 13	N° 8 Ø 3,9 x 38	N° 2 Ø 3,9 x 13	N° 4 Ø 2,9 x 9,5

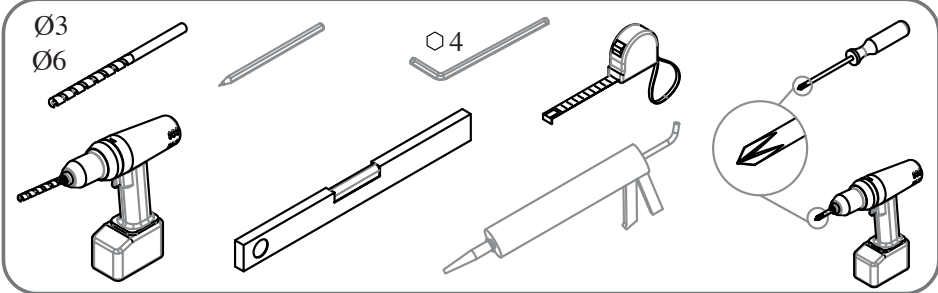

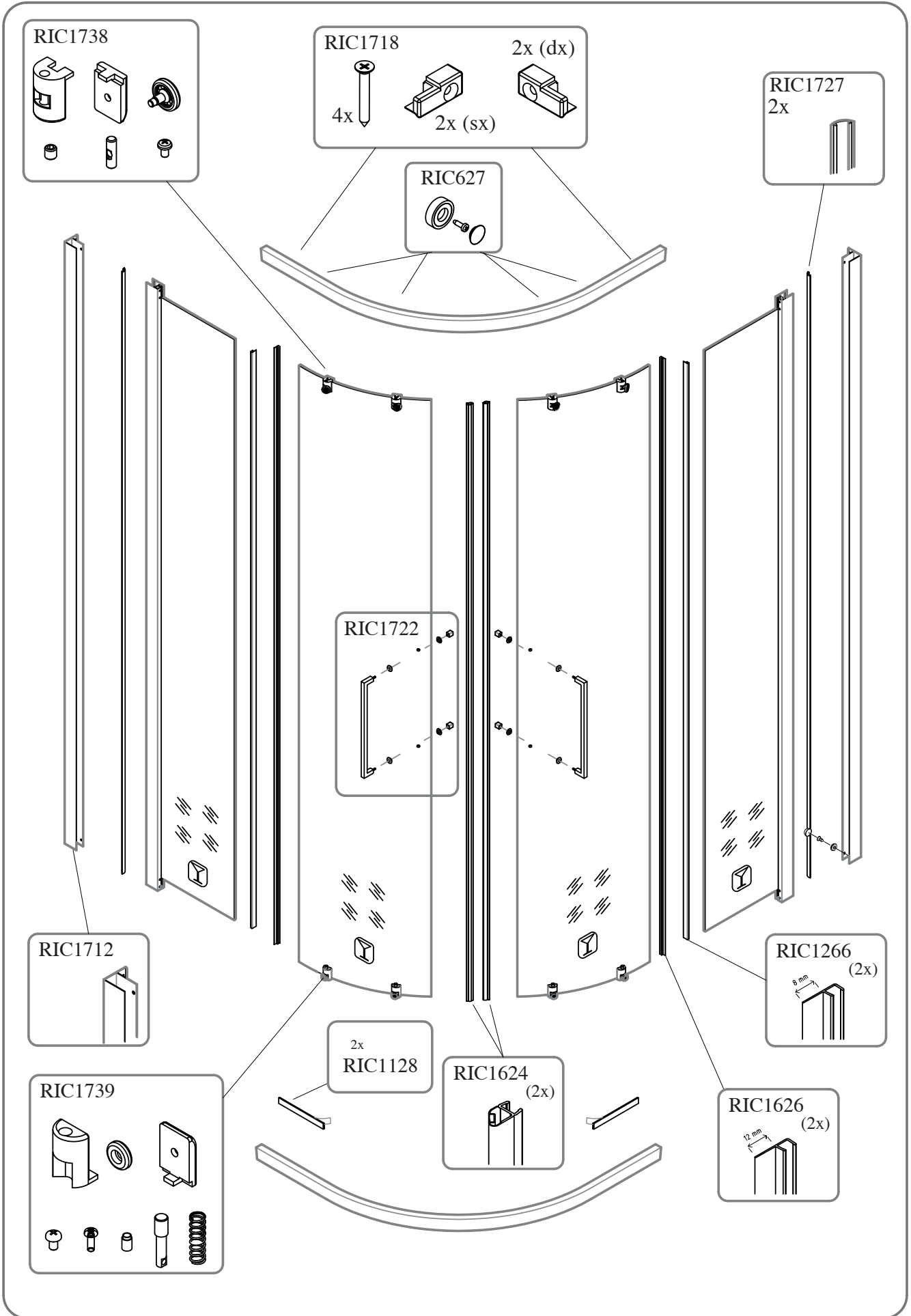

RIC1712

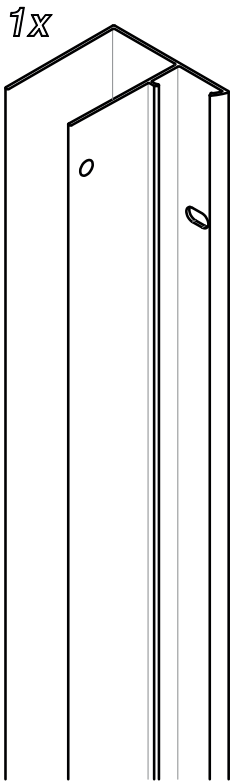

RIC1727

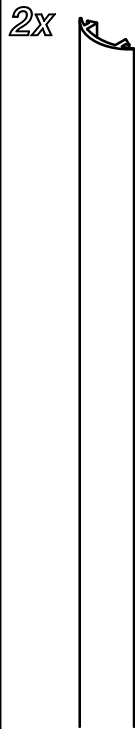

RIC1266



RIC1626



RIC1624

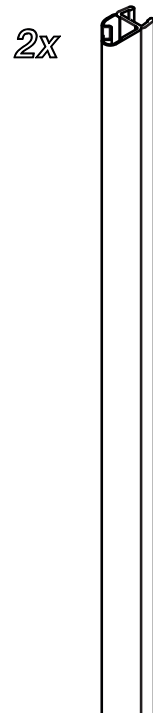

RIC627

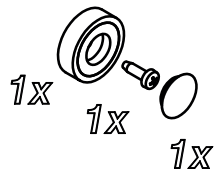

RIC1718

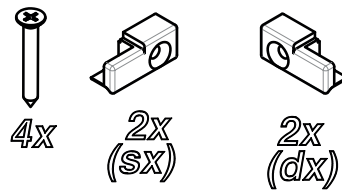

RIC1128



RIC1739

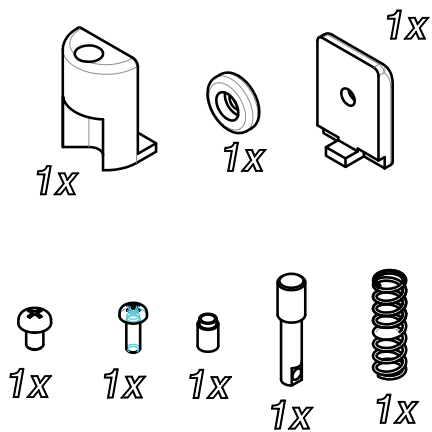

RIC1738

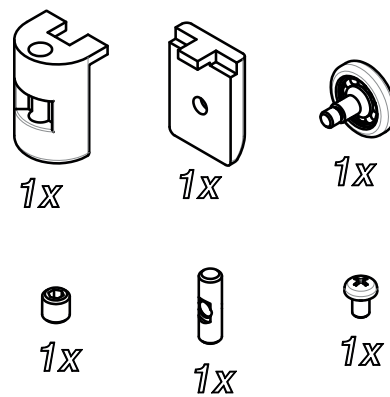

RIC1722

