

# America



**Porta scorrevole a due ante**  
apertura laterale ad anta scorrevole, una fissa ed una apribile.

**Porte de douche coulissante à deux panneaux**  
Ouverture latérale par un panneau coulissant sur un panneau fixe.

**Two panels door.**  
Lateral opening with sliding panel (one fixed and one can be opened).

**Frontal corredera con dos paneles**  
apertura lateral con una hoja fija y una corredera.

**Schiebetür**  
mit einer Festteil und einer Schiebetür.

**Glijdeur met twee panelen**  
Lateraal openschuivende douchewand met één vast en één openschuivend paneel.

**Двустворчатая раздвижная дверь**  
боковое открытие с раздвижной створкой, одна стационарная и другая открывающаяся.



H 185 cm. - V 3 mm.

## Finitura profili

Finitions des profilés\_Profiles finishing \_Acabado perfiles  
Profilfarbe\_Profil afwerkingen \_Отделка профилей

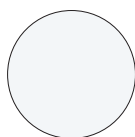

**L01 bianco**  
blanc  
white  
blanco  
Weiß  
wit  
белый

## Finitura pannelli

Finitions des panneaux\_Panels finishing \_Acabado perfiles  
Glasart\_Paneel afwerkingen \_Отделка панелей



**TR trasparente**  
transparent  
transparent  
transparente  
Klarglas  
transparent  
прозрачное

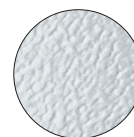

**ST Stampato**  
granité  
frosté  
estampado  
Bedrucktes Glas  
gemarteld  
узорчатое



**JU Juta**  
Juta  
Juta  
Juta  
Juta  
Juta  
Juta

## Porta scorrevole a due ante

Porte de douche coulissante à deux panneaux



Two panels door

Frontal corredera con dos paneles

Schiebetür

Glijdeur met twee panelen

Двустворчатая раздвижная дверь

| Z<br>[cm] | Cod.  | A<br>[cm] | B<br>[cm] | C<br>[cm] | <br>[dm <sup>3</sup> ] | <br>[kg] | <br>[n°] |
|-----------|-------|-----------|-----------|-----------|---|---|---|
| 113-120   | B6841 | 54,7-58,7 | 54,8      | 47        | 119   | 26  | 1   |
|           |       |           |           |           |   | 15  | 1   |
| 121-128   | B6842 | 58,7-62,7 | 58,8      | 51        | 141   | 27  | 1   |
|           |       |           |           |           |   | 16  | 1   |
| 129-136   | B6843 | 63,9-67,9 | 61,6      | 54        | 149   | 27  | 1   |
|           |       |           |           |           |   | 16  | 1   |
| 136-143   | B6805 | 66,9-70,9 | 65,6      | 57        | 155   | 28  | 1   |
|           |       |           |           |           |   | 17  | 1   |
| 146-153   | B6806 | 72,2-76,2 | 70,3      | 62        | 166   | 29  | 1   |
|           |       |           |           |           |   | 18  | 1   |
| 156-163   | B6807 | 77,2-81,2 | 75,3      | 67        | 176   | 30  | 1   |
|           |       |           |           |           |   | 19  | 1   |
| 166-173   | B6808 | 82,2-86,2 | 80,3      | 72        | 186   | 31  | 1   |
|           |       |           |           |           |   | 20  | 1   |

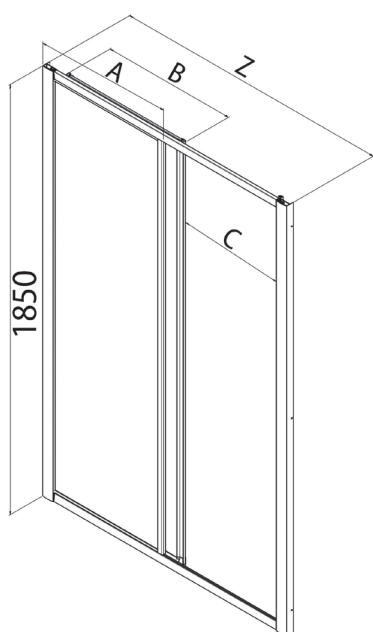

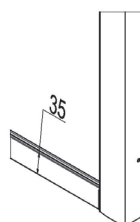
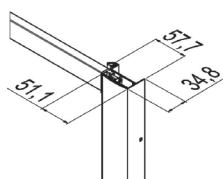
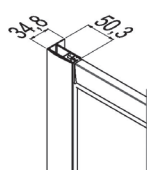
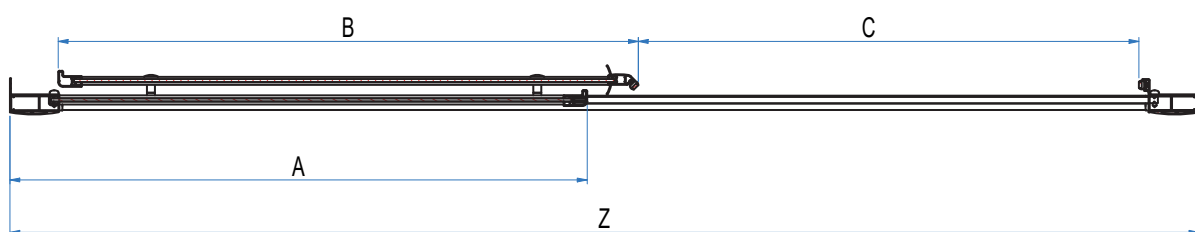
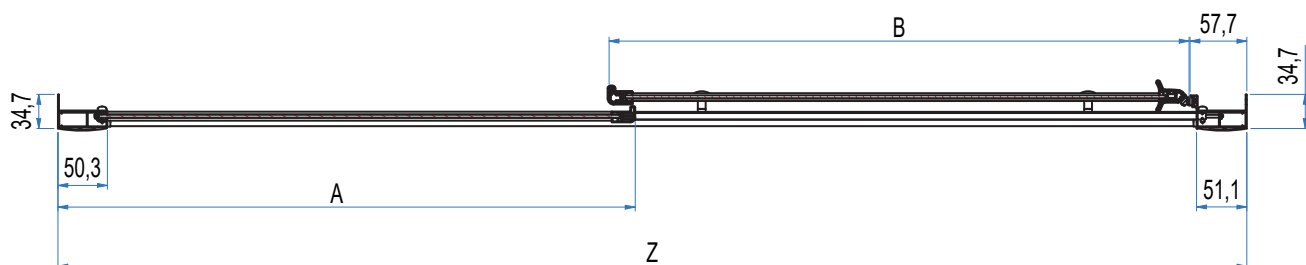



Prodotti Speciali - Produits Spéciaux - Special products - Productos Especiales - Sonderfertigungen - Maatwerk - Специальные Иродукты

|                        |                     |    |                       |                      |
|------------------------|---------------------|----|-----------------------|----------------------|
| MISURE LIMITE          | Altezza max 200 cm. | // | Larghezza max 185 cm. | Larghezza min 80 cm. |
| MESURES LIMITES        | Hauteur max 200 cm. | // | Largeur max 185 cm.   | Largeur min 80 cm.   |
| LIMITS OF MEASUREMENTS | Height max 200 cm.  | // | Width max 185 cm.     | Width min 80 cm.     |
| MEDIDAS LIMITE         | Altura max 200 cm.  | // | Anchura max 185 cm.   | Anchura min 80 cm.   |
| GRENZMAßE              | Höhe max 200 cm.    | // | Breite max 185 cm.    | Breite min 80 cm.    |
| EXTREME MATEN          | Hoogte max 200 cm.  | // | Breedte max 185 cm.   | Breedte min 80 cm.   |
| ПРЕДЕЛЬНЫЕ РАЗМЕРЫ:    | Макс. высота 200 см | // | Макс. ширина 185 см   | Мин. ширина 80 см    |

|  |     |  |  |  |  |  |  |  |  |
|--|-----|--|--|--|--|--|--|--|--|
|  | I   |  |  |  |  |  |  |  |  |
|  | II  |  |  |  |  |  |  |  |  |
|  | III |  |  |  |  |  |  |  |  |

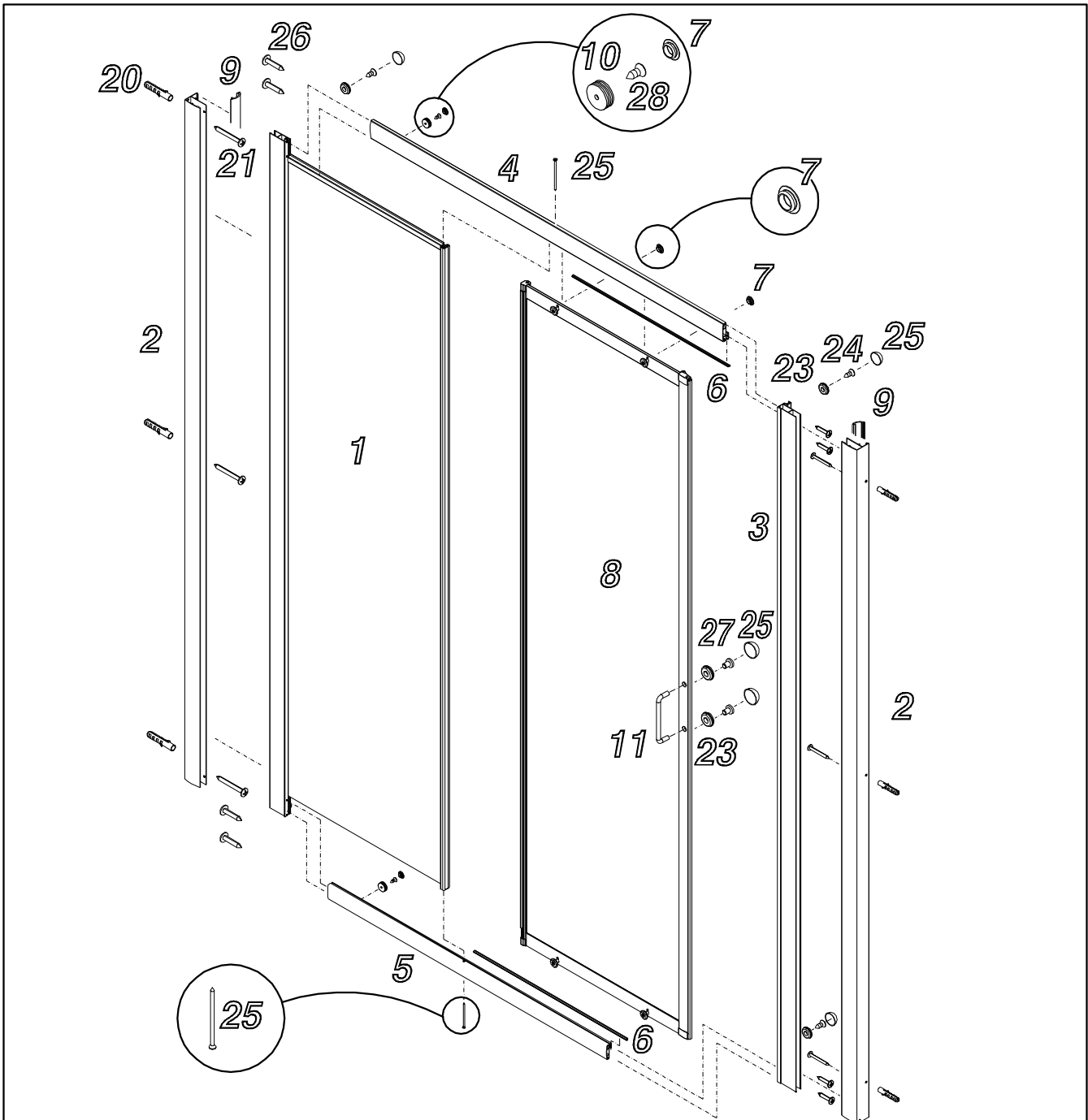

| 20   | 21                 | 22   | 23   | 24                 | 25                 | 26                 | 27            | 28                  |
|------|--------------------|------|------|--------------------|--------------------|--------------------|---------------|---------------------|
|      |                    |      |      |                    |                    |                    |               |                     |
| N° 6 | N° 6<br>∅ 3.9 X 38 | N° 6 | N° 6 | N° 4<br>∅ 3.9 X 13 | N° 2<br>∅ 2.9 X 55 | N° 8<br>∅ 2.9 X 13 | N° 2<br>M4x20 | N° 2<br>∅ 2.9 X 6.5 |

