



Porta scorrevole a due ante.
Apertura laterale ad anta scorrevole, una fissa da 6 mm. ed una apribile da 8 mm. Porta scorrevole installabile solo con parete fissa dedicata.

Porte de douche coulissante à deux panneaux.
Ouverture latérale par un panneau coulissant (mm.8) sur un panneau fixe (mm.6). Profils supérieurs et verticaux portants, absence de profilé inférieur. Déclipsage rapide des panneaux pour en faciliter le nettoyage

Two panels door.
Lateral opening with sliding panel (one fixed mm.6 and one can be opened mm.8). The structure is build of vertical and top profiles, absence of bottom profiles

Frontal con una puerta corredera.
apertura lateral con hoja fija (6 mm.) y una corredera (8 mm.)
La estructura está formada por perfiles verticales y superiores, ausencia de perfiles inferiores

2-tlg Schiebetür.
1-tlg. Schiebetür mit ein festen (mm.6) und eine Schiebetür (mm.8). Obere und senkrechte Tragprofile, sowie dezent gehaltene Profile unten.

Glijdeur met twee panelen.
Lateraal openschuivende douchewand met één vast (mm.6) en één openschuivend paneel (mm.8). Dragende verticale en bovenliggende profielen, profielloos onderaan.

Раздвижная двустворчатая дверь.
Боковое открытие при помощи раздвижной створки, одна стационарная толщиной 6 мм и одна открываемая толщиной 8 мм. Несущие верхние и вертикальные профили, нижние отсутствуют.



H 200 cm. - V 6/8 mm.

Finitura profili

Finitions des profilés
Profiles finishing
Acabado perfiles
Profilfarbe
Profiel afwerkingen
Отделка профилей



SNK
Nickel satinato
Nickel satiné
Satiné nickel
Niquel satinado
Nickel satiniert
Gesatineerd nikkel
Атласный никель

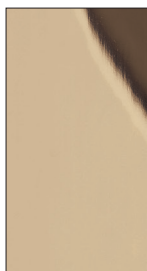

AL4
Alluminio bronzo
Aluminium bronze
Bronze aluminium
Aluminio bronco
Bronze AluminiumBrons
aluminium
Алюминиевая бронза



AL5
Alluminio oro rosato
Aluminium or rose
Pink gold aluminium
Aluminio oro rosa
Rotgold Aluminium
Roségoud aluminium
Алюминий розовое золото



AL6
Alluminio nero
Aluminium noir
Black aluminium
Aluminio negro
Schwarzes Aluminium
Zwart aluminium
Черный алюминий

Finitura pannelli

Finitions des panneaux
Panels finishing
Acabado perfiles
Glasart
Paneel afwerkingen
Отделка панелей

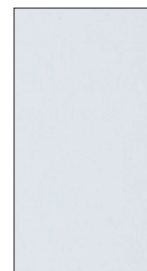

TR
trasparente
transparent
transparent
transparente
Klarglas
transparent
прозрачное



TG
trasparente Grigio
transparent Gris
transparent Grey
transparente gris
Klarglas Grau
transparent. Grijs
серое прозрачное



SY
vetro a specchio
Verre miroir
mirrored glass
cristal de espejo
Spiegelglas
Spiegelend glas
стекло зеркало

Porta scorrevole a due ante

Porte de douche coulissante à deux panneaux

Two panels door

Frontal con una puerta corredera



2-tlg Schiebetür

Glijdeur met twee panelen

Раздвижная двустворчатая дверь



Trattamento anticalcare di serie compreso nel prezzo
 Traitement anti-calcaire inclus dans le prix
 Anti-limescale treatment included in the price
 Tratamiento antical incluido en el precio
 Gegen Kalkablagerungen schützende Glasbehandlung im Preis inbegriffen
 Anti-kalkafwerking inbegrepen in de prijs
 Средство от известкового налета включено в цену

Cod.	Z [cm]	A [cm]	B [cm]	C [cm]	D [cm]	 [dm ³]	 [kg]	 [n°]
B8730	98-101	47	48	40	//	150	42	2
B8731	108-111	52	53	45	//	150	47	2
B8732	118-121	57	58	50	//	170	51	2
B8733	128-131	62	63	55	//	200	56	2
B8734	138-141	67	68	60	//	240	56	2
B8735	158-161	77	78	70	//	260	65	2
B8736	168-171	87	78	70	//	260	69	2
B8737	178-181	97	78	70	//	430	72	2

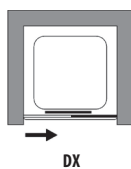
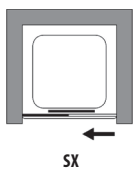

580 mm

Interasse maniglia
 Empattement de la poignée
 Handle wheelbase
 Distancia entre ejes de la manija
 Radstand handhaben
 Handvat wielbasis
 Колесная база ручки

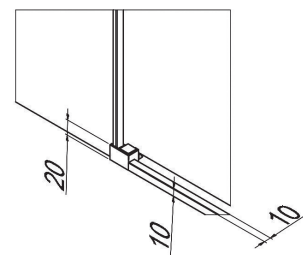
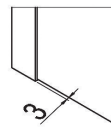
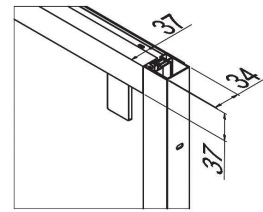
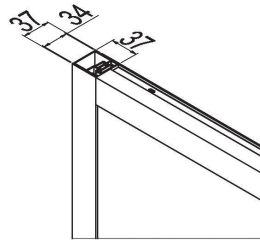
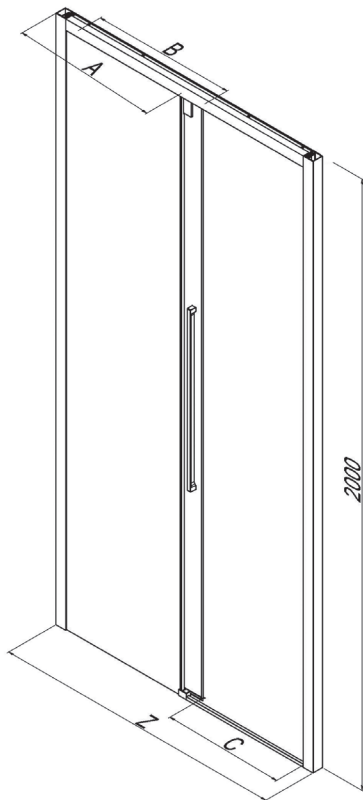
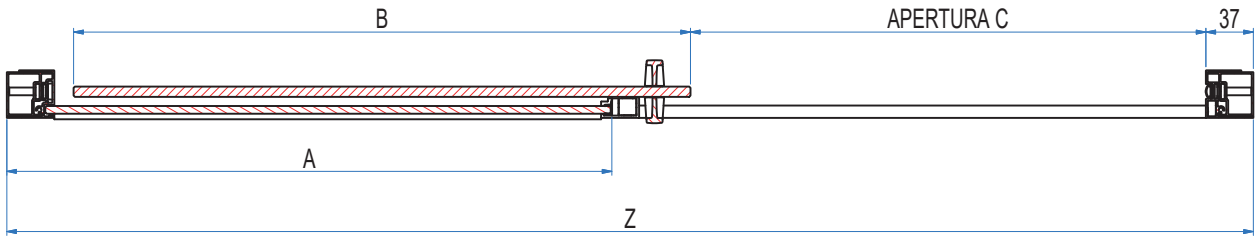
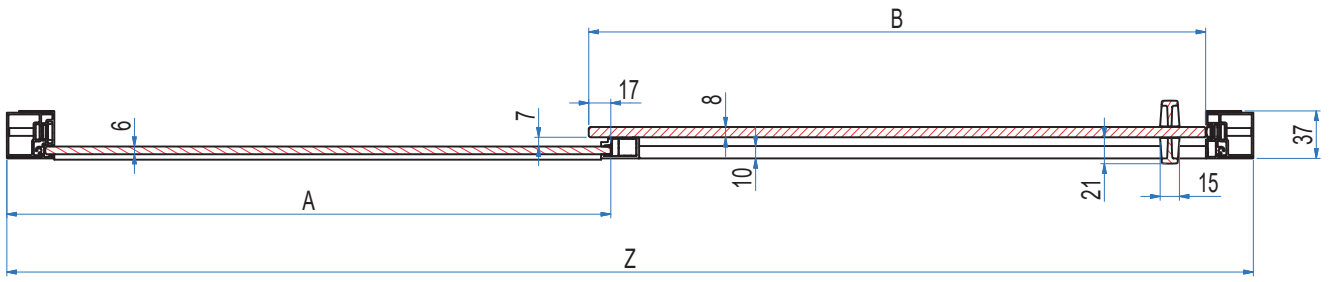

Prodotti Speciali - Produits Spéciaux - Special products - Productos Especiales - Sonderfertigungen - Maatwerk - Специальные Иродукты								
MISURE LIMITE	Altezza max 210 cm.	Larghezza max 200 cm.	Larghezza min 90 cm.					
MESURES LIMITES	Hauteur max 210 cm.	Largeur max 200 cm.	Largeur min 90 cm.					
LIMITS OF MEASUREMENTS	Height max 210 cm.	Width max 200 cm.	Width min 90 cm.					
MEDIDAS LIMITE	Altura max 210 cm.	Anchura max 200 cm.	Anchura min 90 cm.					
GRENZMAßE	Höhe max 210 cm.	Breite max 200 cm.	Breite min 90 cm.					
EXTREME MATEN	Hoogte max 210 cm.	Breedte max 200 cm.	Breedte min 90 cm.					
ПРЕДЕЛЬНЫЕ РАЗМЕРЫ:	Макс. высота 210 см	Макс. ширина 200 см	Мин. ширина 90 см					
	I							
	II							
	III							

Maniglia optional solo su richiesta, 1 pezzo - Ручка, не входящая в комплект стандартной поставки, поставляется по отдельному заказу, одна штука.
Poignée optionnelle seulement sur demande, 1 pièce - Optional handle only on request, 1 piece

N00 CRO_SNK_SL4_AL5_AL6_ELO



L00 CRO_SNK_SL4_AL5_AL6_ELO



M00 CRO_SNK_SL4_AL5_AL6_ELO



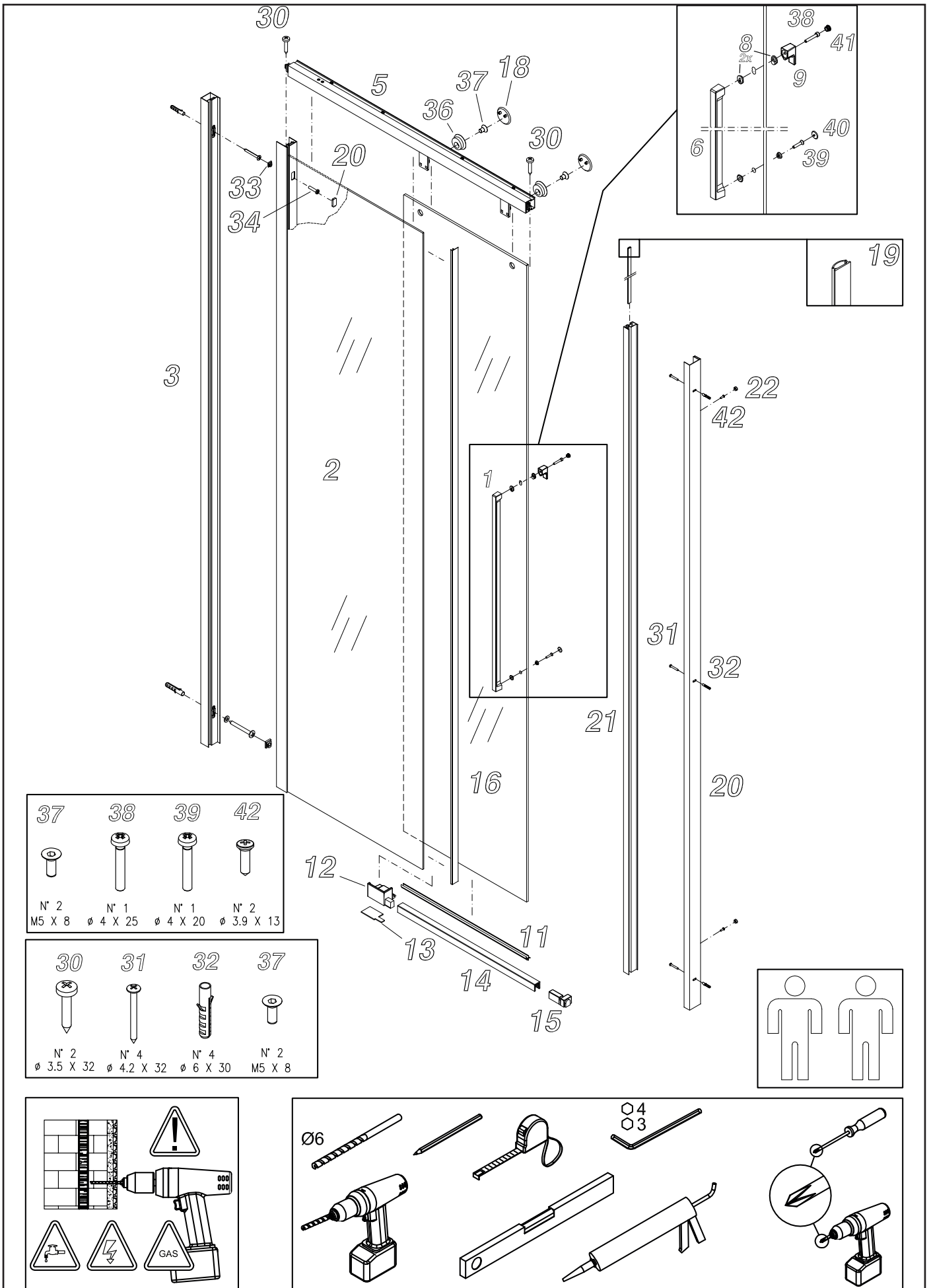

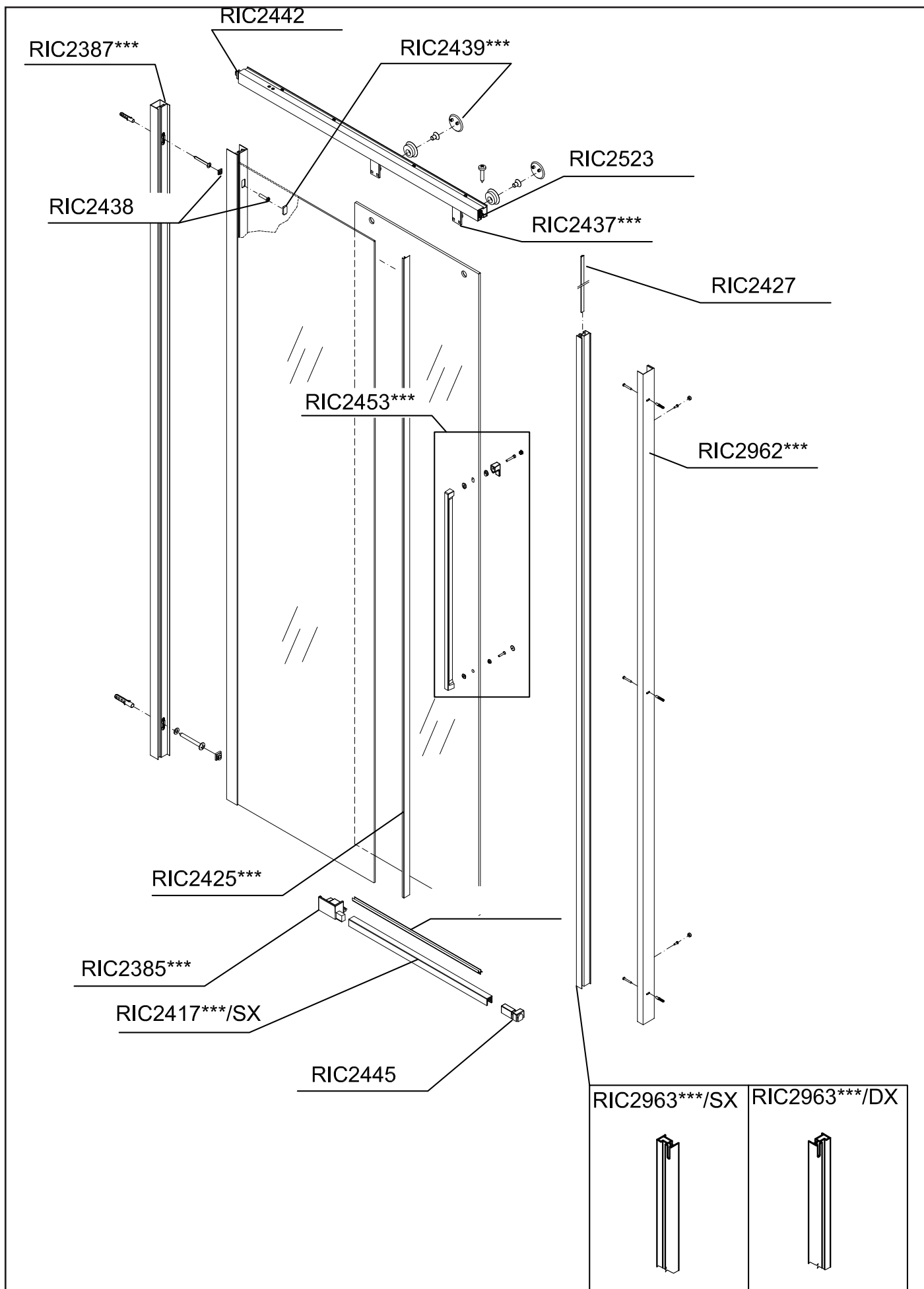

<p>RIC2387***</p> <p>1x</p>	<p>RIC2963***/SX</p> <p>1x</p>	<p>RIC2963***/DX</p> <p>1x</p>	<p>RIC2962***</p> <p>1x</p>	<p>RIC2425***</p> <p>1x (sx) 1x (dx)</p>
<p>RIC2426</p> <p>1x</p>	<p>RIC2417***/SX</p> <p>1x</p>	<p>RIC2417***/DX</p> <p>1x</p>	<p>RIC2442</p> <p>2x 2x 4x Ø 3,5 X 32 Ø 3,5 X 38</p>	<p>RIC2523</p> <p>1x 1x 2x Ø 3,5 X 32 Ø 3,5 X 38</p>
<p>RIC2443</p> <p>1x</p> <p>2x Ø 3,9 X 22 2x Ø 4</p>			<p>RIC2385***</p> <p>1x (sx) 1x (dx)</p>	<p>RIC2445</p> <p>1x (sx) 1x (dx)</p>
<p>RIC2439***</p> <p>4x 4x</p>	<p>RIC2437***</p> <p>2x</p>	<p>RIC2427</p> <p>1x</p>	<p>RIC2444</p> <p>1x</p>	<p>RIC2453***</p> <p>1x</p> <p>2x 1x 1x 1x 1x 1x 1x</p>
<p>RIC2429***</p> <p>1x</p>				